

Bezpečnostní ovládací tlačítka

Používají se na bezpečné ovládání obráběcích strojů v dílnách, opravných, montážních halách. Zabraňují opětovnému zapnutí ovládaného zařízení v případě výpadku napájecího napětí, tak aby nedocházelo k úrazu při jeho obnovení (např. na soustruhu nebo pile). Znovuzapnutí je možné až po opakovaném stlačení zeleného tlačítka „I“. Tlačítko ON „I“ zapíná, tlačítko OFF „O“ vypíná spínací kontakty. Bezpečnostní funkci proti znovuzapnutí realizuje zabudované ochranné vypínací relé. Také nabízíme typ s vyvedeným externím kontaktem vypínacího relé. V případě výpadku napětí tlačítka, odpojí zabudované vypínací relé připojeného zařízení od napájení. Upozornění: Při jejich montáži je nutné dbát na správné zapojení uvedené na těle tlačítek.



SSTM-01..



TRACON SSTM-01

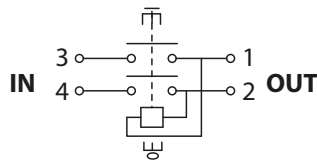

TRACON SSTM-015

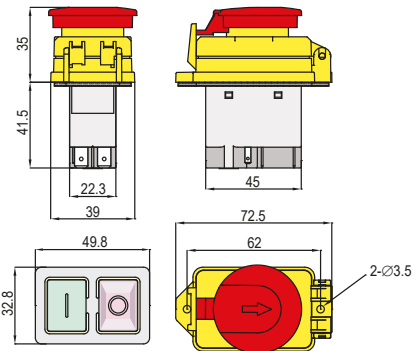
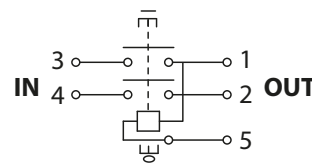

230 V AC
I_e (AC 3, 230 V) 12 A
6,3x0,8 mm
×10⁴



SSTM-02..



TRACON SSTM-02

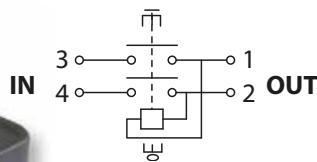

TRACON SSTM-025

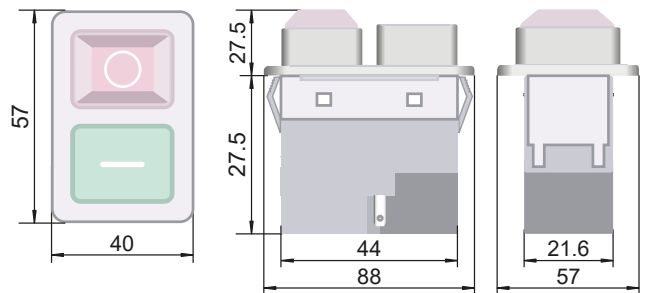
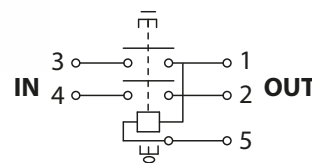

230 V AC
I_e (AC 3, 230 V) 12 A
6,3x0,8 mm
5×10⁴



SSTM-03..



TRACON SSTM-03

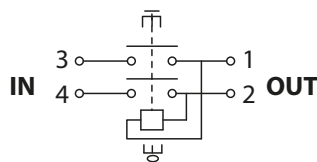

TRACON SSTM-035

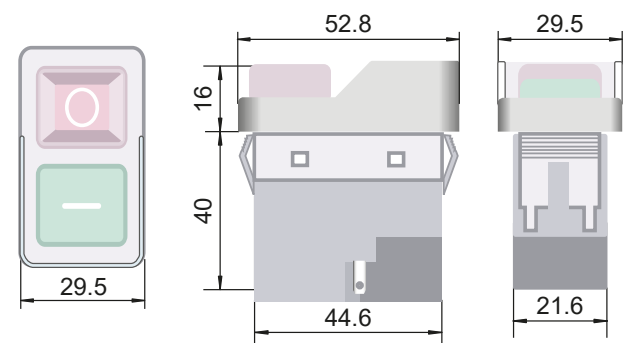
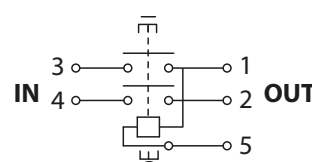

230 V AC
I_e (AC 3, 230 V) 12 A
6,3x0,8 mm
5×10⁴



SSTM-04..

**230
V AC**

**I_e (AC 3, 230 V)
12 A**

6,3×0,8 mm

5×10⁴

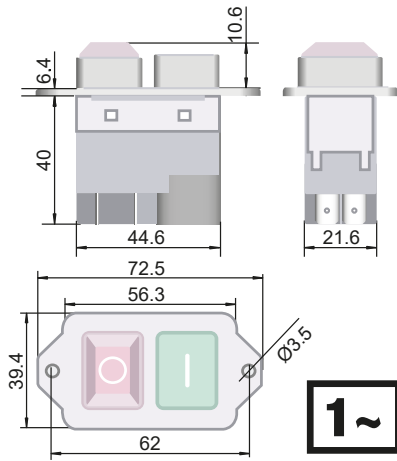

TRACON SSTM-04

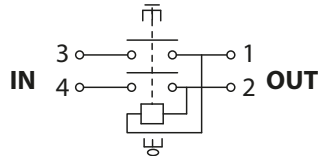

TRACON SSTM-045

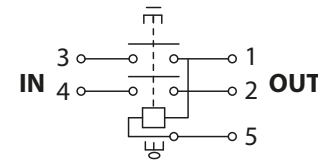

SSTM-31..

**400
V AC**

**I_e (AC 3, 400 V)
8 A**

6,3×0,8 mm

×10⁴

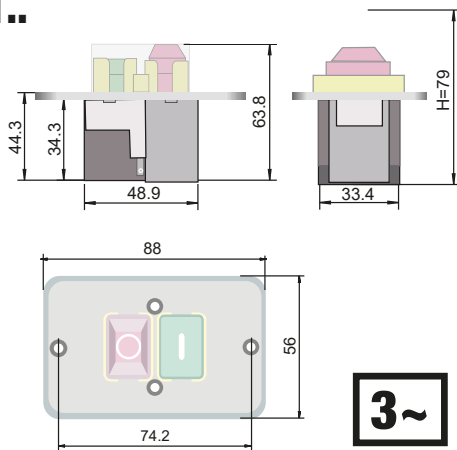

TRACON SSTM-316

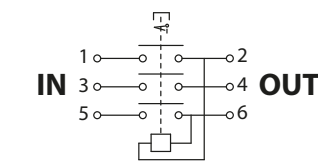

TRACON SSTM-317

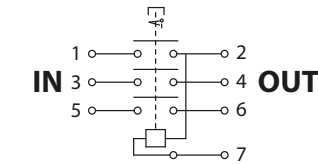

SSTM-32..

**400
V AC**

**I_e (AC 3, 400 V)
8 A**

6,3×0,8 mm

5×10⁴

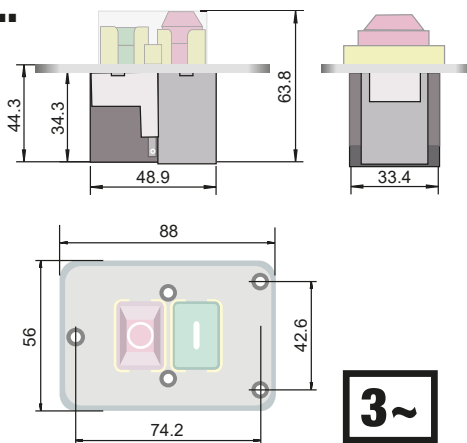

TRACON SSTM-326

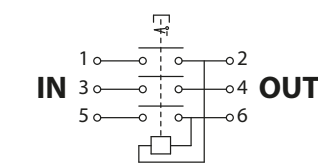

TRACON SSTM-327

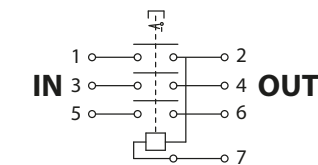

Nadomítkové instalační krabice bez vývodů



M/15

SSTM-BOX

Použitelné k následujícím typům:

SSTM-02, -025

SSTM-316, -317

SSTM-326, -327

113×77×60 mm



**IP
42**

TRACON SSTM-BOX

