

-10°C ... +70°C	-5°C ... +35°C	10°C ... 30°C	250 V~ 8 A, cos φ = 1 2 A, cos φ = 0,6	6 mm
P	U, f			
< 1 W	230 V~ 50 / 60 Hz	ΔK = ±2K		1,5..4 mm ²
				1,5..2,5 mm ²

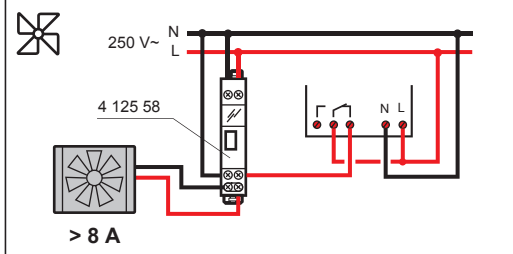

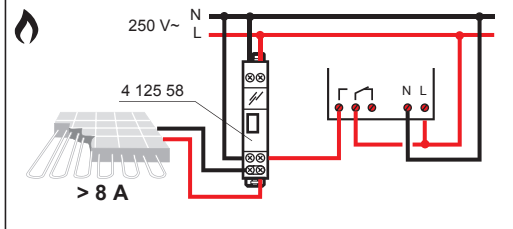

OFF	

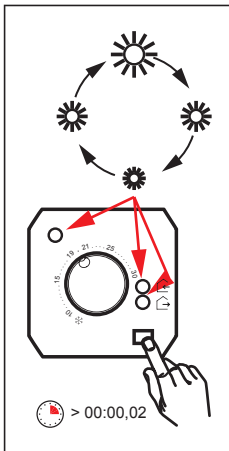
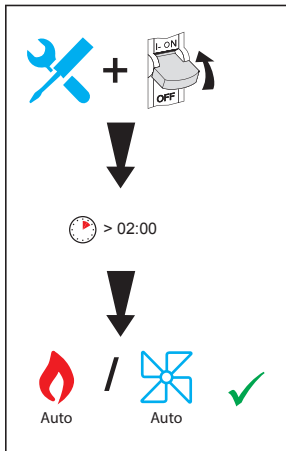
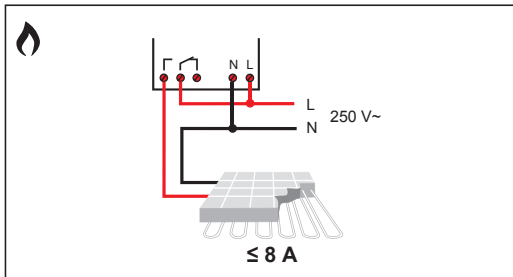
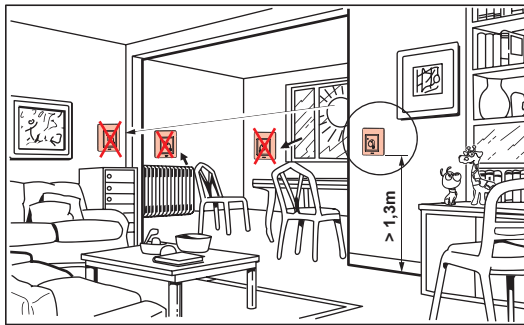
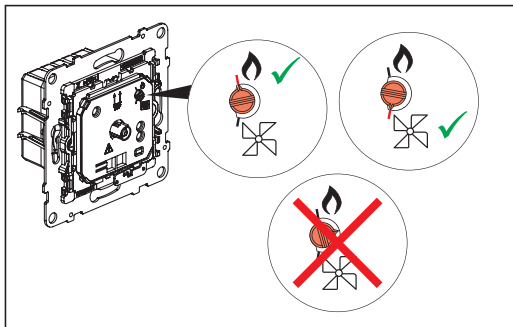
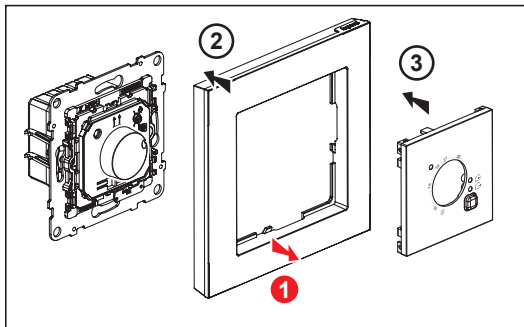
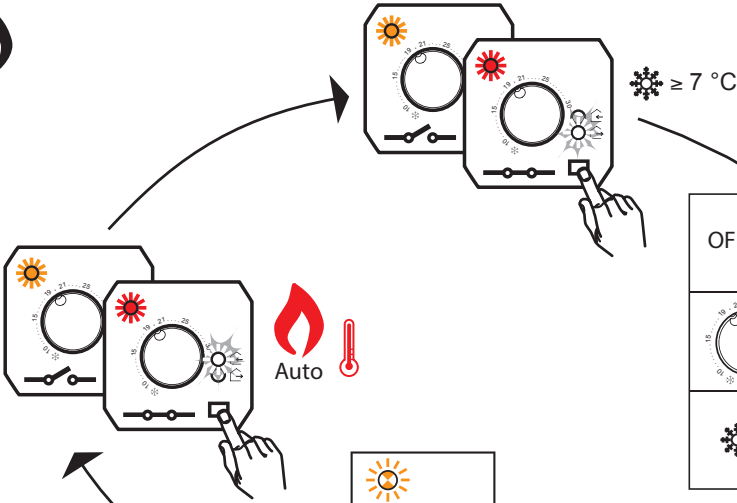
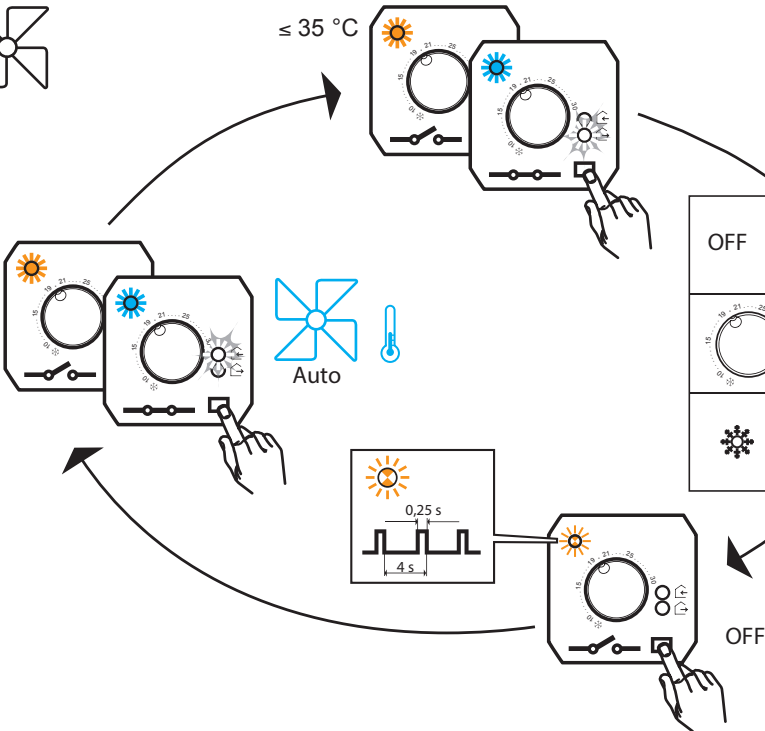

OFF	