

**Description** : Flat Lithium Battery  
**Chemical system** : Lithium Manganese Dioxide  
**Nominal voltage** : 3 Volts  
**Nominal capacity** : 300mAh@6.8kΩ to 2.5V  
**Dimensions** :  $\phi 24.5 \times 3.0$ mm  
  
**Average weight** : 4 grams  
**Application** : Watch, calculator, camera and memory back up

### Cross References:

IEC	JIS	Eveready	Varta	Duracell
CR2430	CR2430	ECR2430	CR2430	DL2430

Model No.: **CR2430**

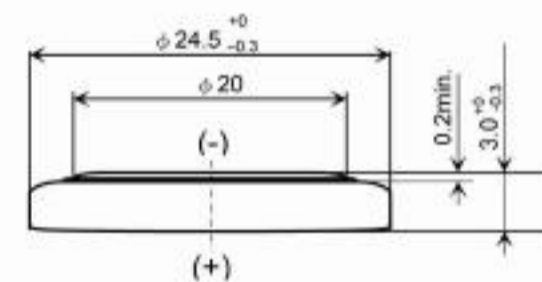
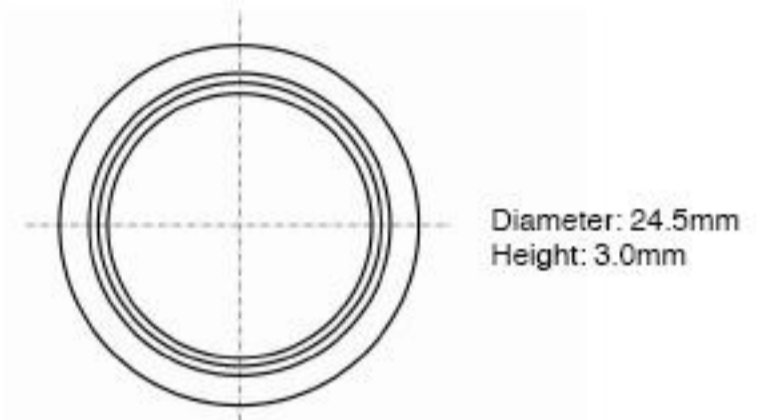

**Dimension Drawing**

### Discharge Characteristics on Load

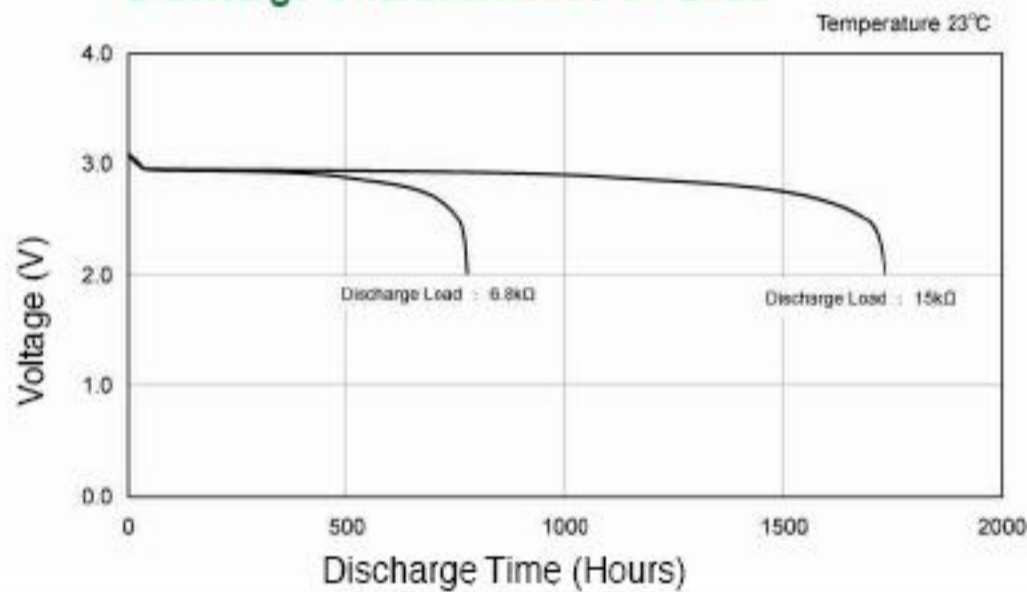

### Discharge Characteristics on Temperature

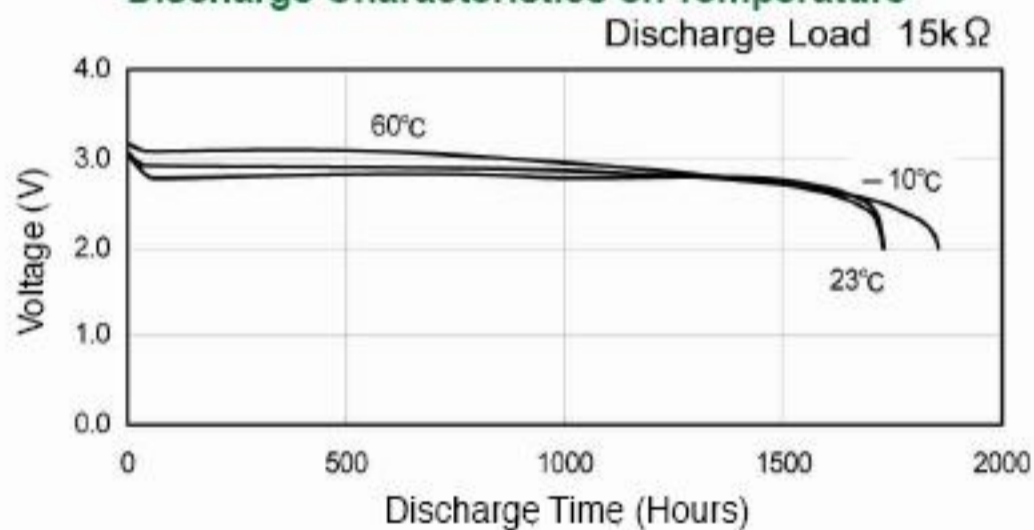

### Discharge Load vs. Discharge Capacity

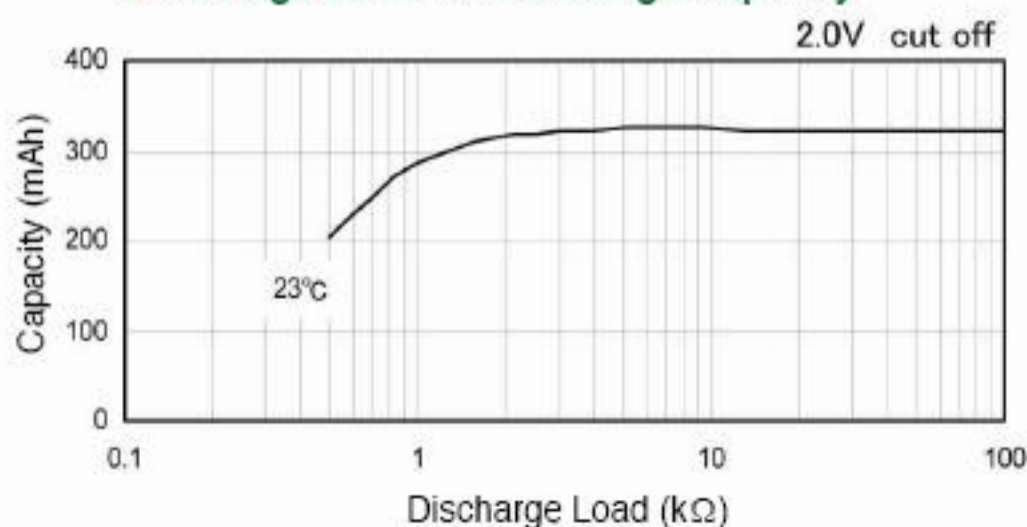

### Discharge Characteristics on Pulse Load

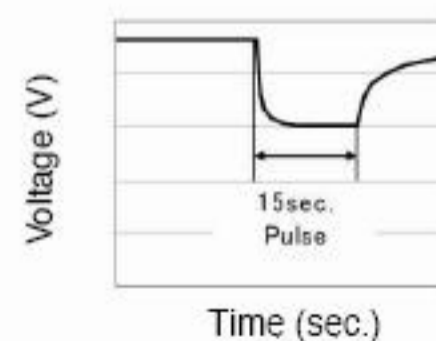
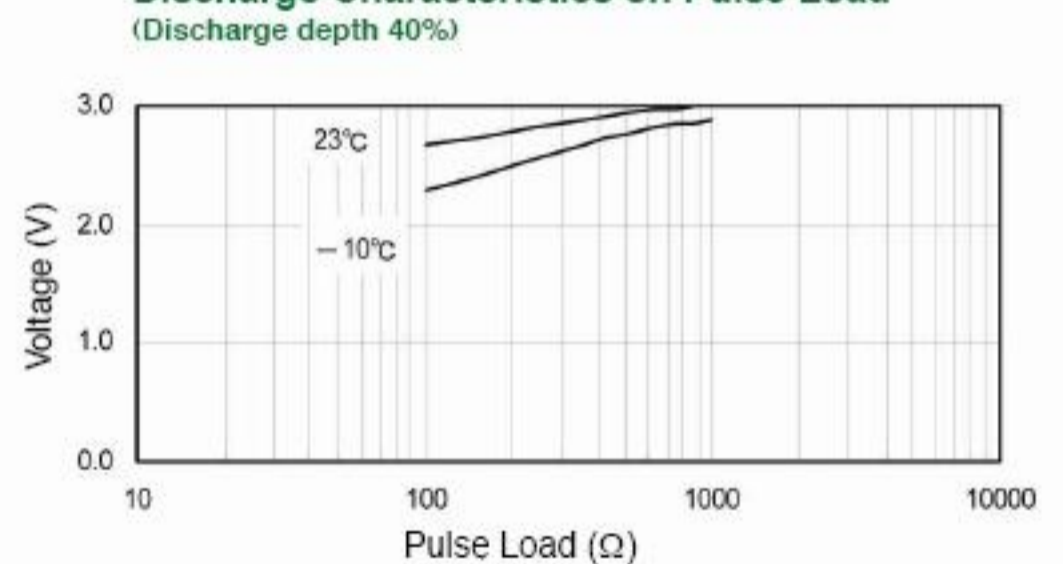

The information (subject to change without prior notice) contained in this document is for reference only and should not be used as a basis for product guarantee or warranty. For applications other than those described here, please consult your nearest GP Sales and Marketing Office or Distributors.